

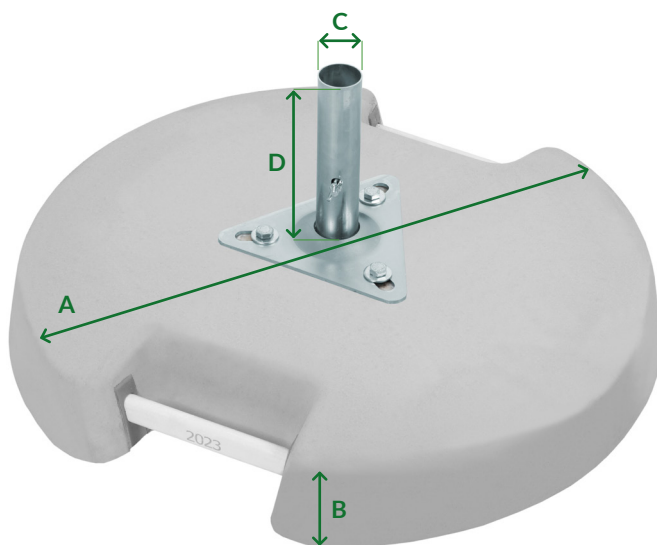

Podstawa Rodos 4 m



Materiał	beton, stal, aluminium
Wymiary [mm]	A Ø 700 B 120 C Ø 45 D 200
Waga netto [kg]	80 ±3%

